



***AIRCAD, INC***  
***STOCK CATALOG***

*Warehouse stock ready for immediate pick-up  
or delivery.*

**AIRCAD INC**  
7050 So. 109th Ave.  
LaVista, NE 68128  
(402) 932-1220  
www.aircad.com  
E-mail: sales@aircad.com

# *Customer Satisfaction Guaranteed*

We understand our customers needs. Our sales people travel the country to attend training sessions at all the factories we represent. Consequently, our sales people have an in-depth knowledge of products and applications to assist you in your building projects.

In order to better serve you, we carry a variety of products onsite; ready for immediate pick-up or delivery. (Delivery charges may apply)

***AIRCAD, INC.***

***402-932-1220***

**See our lines list for all factories represented by *AIRCAD, INC.* All factory products can be ordered and direct shipped. Call for pricing and details. Ask about Quick Ship options.**

***Matt Bordenkecher***      ***EXT. 1***

***Brad Klaassen***      ***EXT. 2***

***Pat Dotson***      ***EXT. 4***

***Jamie Mills***      ***EXT. 6***

***Steve Morlan***      ***EXT. 7***

***Bob Palmore***      ***EXT. 8***



Catalog prices subject to change without notice.

**Model: SCD**

**Features**

- . Louvered Face
- . All steel construction
- . White powder coat finish
- . 3 lay-in frame sizes
- . Plaster frames (optional)

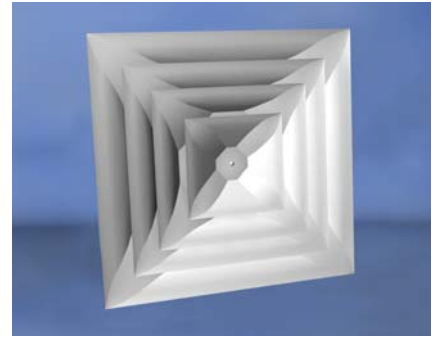

Neck Size	CFM Range	Face Size
6"	100-200	12 x 12
6"	100-200	20 x 20
8"	200-360	
6"	100-200	24 x 24
8"	200-360	
10"	350-550	
12"	550-780	
14"	750-1050	

**Model: SCDA**

**Features**

- . Louvered Face Adjustable
- . Horizontal or Vertical
- . All steel construction
- . White powder coat finish
- . Plaster frames (optional)



Neck Size	CFM Range	Face Size
6"	100-200	24 x 24
8"	200-360	
10"	350-550	
12"	550-780	
14"	750-1050	

**Model: SPD**

**Features**

- Plaque Diffuser
- All steel construction
- Wrapped panel
- White powder coat finish
- Plaster frames (optional)



Neck Size	CFM Range	Face Size
6"	100-200	12 x 12
8"	200-350	
6"	100-200	24 x 24
8"	200-360	
10"	350-550	
12"	550-780	
14"	650-1050	

**Model: VPD-H/C**

**Features**

- Thermally powered VAV diffuser
- Auto Heat/Cool changeover
- Hinged plaque with magnetic closure (standard)
- White powder coat finish
- Plaster frames (optional)

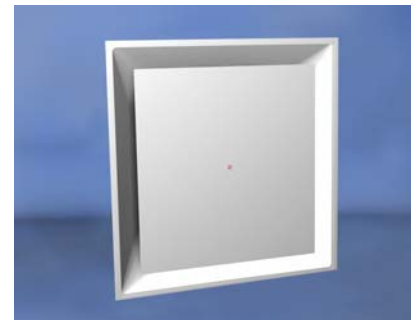

Neck Size	CFM Range	Face Size
8"	140-240	24 x 24
10"	220-500	24 x 24

**Model: 520D**

**Features**

- Steel construction
- Double deflection — 3/4" spacing
- Opposed blade damper included
- Blades individually adjustable
- Front blades parallel to short dimension
- White powder coat finish

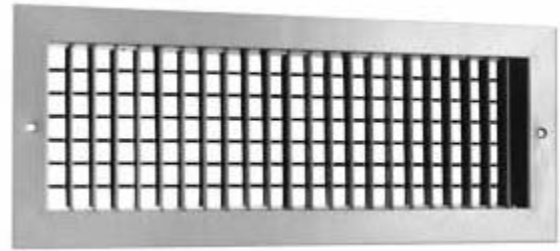

**Available Sizes:**

		Width			
		6"	8"	10"	12"
Height	4"	-	✓	✓	-
	6"	✓	✓	✓	✓
	8"	-	✓	✓	✓
	10"	-	-	✓	✓
	12"	-	-	-	✓

**Model: 530**

**Features**

- Steel construction
- 35 degree deflection — 3/4" spacing
- Fixed louvered face
- White powder coat finish



**Available Sizes:**

		Width			
		6"	8"	10"	12"
Height	4"	-	✓	✓	-
	6"	✓	✓	✓	✓
	8"	-	✓	✓	✓
	10"	-	-	✓	✓
	12"	-	-	-	✓

**Model: 80****Features**

- Aluminum eggcrate construction
- ½ x ½ x ½ grid size
- White powder coat finish
- 3 lay-in frame sizes

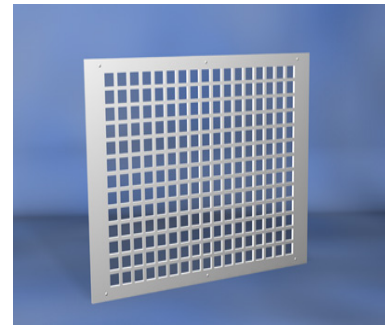

Neck Size	CFM	Face Size
10 x 10	550	12 x 12
22 x 10	1100	24 x 12
22 x 22	2200	24 x 24

**Model: PDDR****Features**

- Perforated Return w/ Collar
- 3 lay-in frame sizes
- White powder coal finish



Neck Size	CFM	Face Size
10 x 10	500	12 x 12
22 x 10	1000	24 x 12
22 x 22	2200	24 x 24

## **Model PFRF**

### **Features**

- Perforated Return—Face only
- 2 Lay-in frame sizes
- White powder coat finish

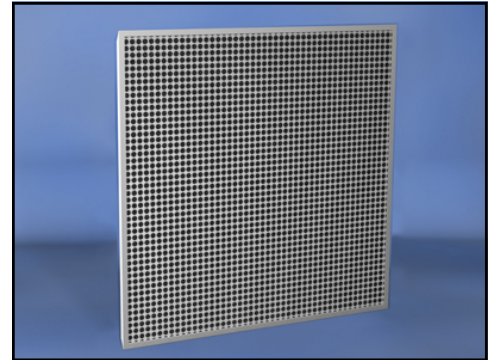

Face Size	CFM Range
24 x 12	0-1375
24 x 24	0-2700

## **Model: 530FF**

### **Features**

- Filter Grille
- Accepts standard 1" filter media
- 1/4 turn fasteners and hinge
- Lay-in frame
- White powder coat finish



Filters not included

Neck Size	Face Size	CFM Range
20x20	24x24	0-1200

## Accessories: SPF and VCR 8E



### Model SPF

Steel Surface Mount Adaptor Frame  
Rough opening is 1/4" larger than listed size.



Size
12 x 12
12 x 24
20 x 20
24 x 24

### VCR 8E Butterfly Damper

Damper mounts directly to any round diffuser neck inlet that is sized nom.-1/8".

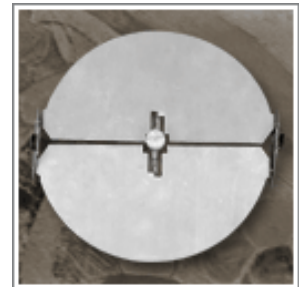

Nominal Sizes	A	B
6"	5-7/8 (150)	2-3/4
8"	7-7/8 (200)	3-3/4
10"	9-7/8 (250)	4-3/4
12"	11-7/8 (302)	5-3/4
14"	13-7/8	6-3/4



## **Model: SDV5**

### **Features**

- . Variable or Constant Volume Box
- . Inlet Flow Sensor
- . 3/4" Fiber-free Insulation
- . DDC Controls by others
- . Pneumatic Controls Available

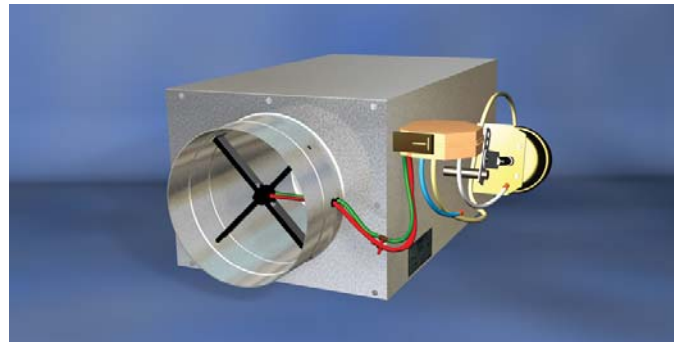

Neck Size	CFM
6"	200-375
8"	400-700
10"	700-1000
12"	1000-1800
14"	1700-2500

Pneumatic Controller Kit (controller, actuator, linkage)

Pneumatic Controllers Only (CP101)

Pneumatic Actuator Only

## **Hot Water Coils**

Row	Box Size	Coil Size
1 row	6"	12 x 8
1 row	8"	12 x 10
1 row	10"	14 x 12.5
1 row	12"	16 x 15
2 rows	6"	12 x 8
2 rows	8"	12 x 10
2 rows	10"	14 x 12.5
2 rows	12"	16 x 15

## Ceiling Exhaust Fans

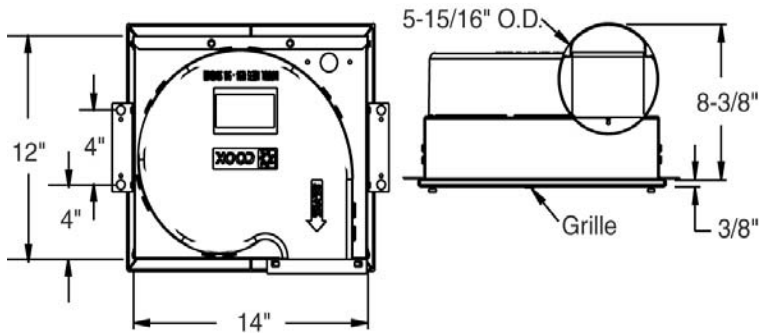

Model	CFM
GC-122/124	76/56
GC-142/144	132/85
GC-162/164	143/102
GC-182/184	253/224

6" Wall Caps— Fits All
Fan Speed Controller— Fits All
Grease Canister for Cook VCR Fans

**Factory Rush Program: Nearly all fan models available with 24-hour express shipping from Loren Cook. See Cook Express Catalog for details.**



## Economy Ceiling Exhaust Fans

### Features

- Torsion Spring Grille Mounting—No Tools Required
- Compact Housing Fits Easily Between Ceiling Joists

Model	CFM	Collar
671	70	3"
676	110	4"
684	90	4"
688	50	3"



## High Capacity Ceiling Exhaust Fans

### Features

- Single impact-resistant centrifugal blower wheel
- 20 ga. Galvanized Steel Housing.
- Round Duct Connector

Model	CFM	Collar
L-150	180	6"
L-200	230	8"
L-300	312	8"



## Ceiling Exhaust Fans w/Radiation Damper

Model	CFM	Collar
RDH	Housing	4"
80RDF	80	-
110RDF	110	-



## Grease Access Doors

**Features:**

- . 16 gage black iron construction
- . Services up to +2,000 °F
- . High temp. ceramic rope gasket



Model	Size
ADF-KE	10 x 6
ADF-KE	16 x 12

## Duct Access Doors

**Features:**

- . 22 gage galvanized steel, double panel
- . Continuous aluminum piano hinge
- . Door panel filled w/2" fiberglass insulation
- . Neoprene gasketing, cam latch



Model	Size
HD-5070	6 x 6
HD-5070	8 x 8
HD-5070	10 x 10
HD-5070	12 x 12